

Discovery kit for STM32F407/417 lines

Introduction

The STM32F4DISCOVERY helps you to discover the STM32F407 & STM32F417 lines' high-performance features and to develop your applications. It is based on an STM32F407VGT6 and includes an ST-LINK/V2 embedded debug tool interface, ST MEMS digital accelerometer, ST MEMS digital microphone, audio DAC with integrated class D speaker driver, LEDs, pushbuttons and a USB OTG micro-AB connector.

Figure 1. STM32F4DISCOVERY

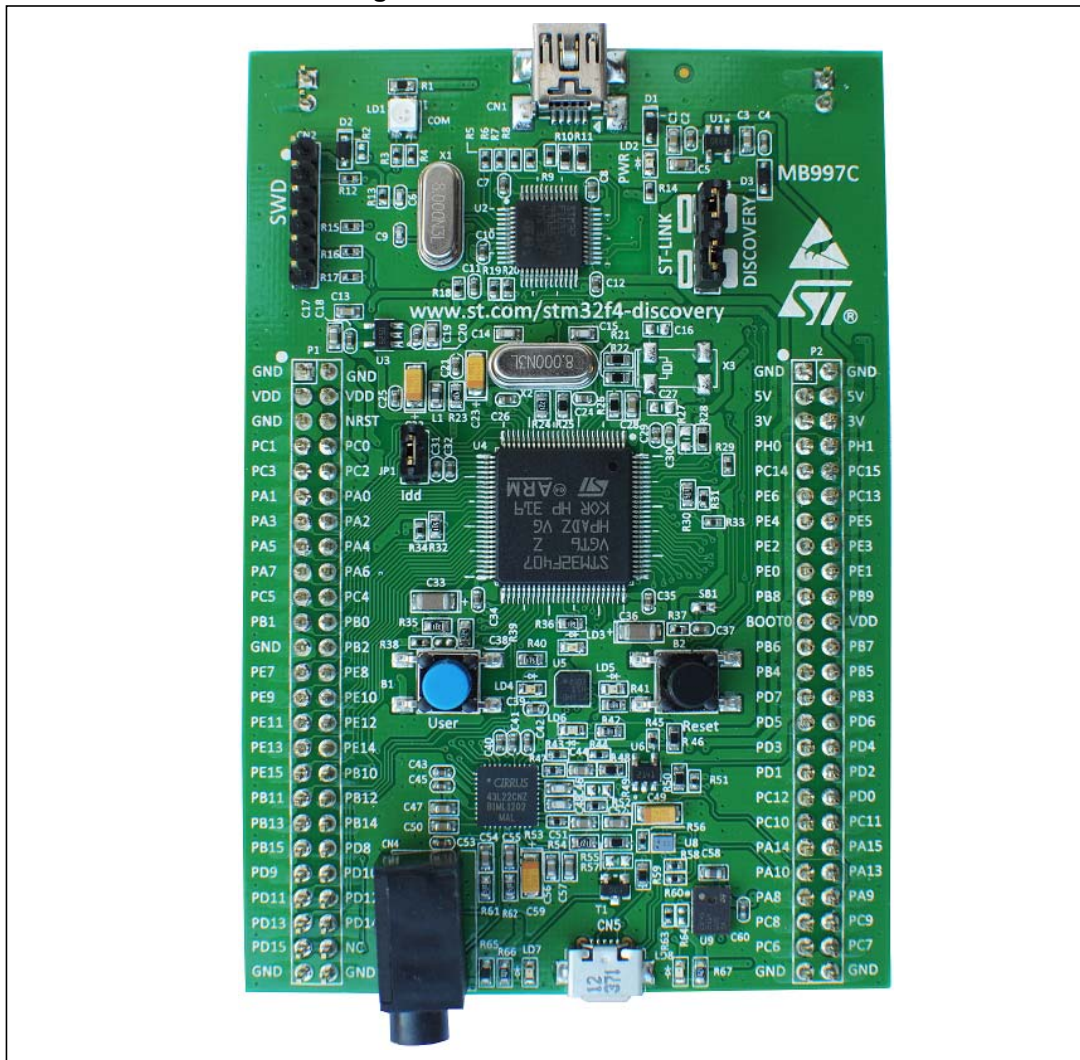

1. Picture not contractual

Contents

- 1 Conventions 5**
- 2 Quick start 6**
 - 2.1 Getting started 6
 - 2.2 System requirements 6
 - 2.3 Development toolchain supporting the STM32F4DISCOVERY 6
 - 2.4 Order code 6
- 3 Features 7**
- 4 Hardware and layout 8**
 - 4.1 STM32F407VGT6 microcontroller 11
 - 4.2 Embedded ST-LINK/V2 13
 - 4.2.1 Using ST-LINK/V2 to program/debug the STM32F4 on board 14
 - 4.2.2 Using ST-LINK/V2 to program/debug an external STM32 application .. 15
 - 4.3 Power supply and power selection 16
 - 4.4 LEDs 16
 - 4.5 Pushbuttons 16
 - 4.6 On board audio capability 17
 - 4.7 USB OTG supported 17
 - 4.8 Motion sensor (ST MEMS LIS302DL or LIS3DSH) 17
 - 4.9 JP1 (Idd) 18
 - 4.10 OSC clock 19
 - 4.10.1 OSC clock supply 19
 - 4.10.2 OSC 32 KHz clock supply 19
 - 4.11 Solder bridges 20
 - 4.12 Extension connectors 21
- 5 Mechanical drawing 34**
- 6 Electrical schematics 35**
- 7 Revision history 41**



List of tables

Table 1.	ON/OFF conventions	5
Table 2.	Jumper states	13
Table 3.	Debug connector CN2 (SWD).	15
Table 4.	Solder bridges.	20
Table 5.	MCU pin description versus board function	21
Table 6.	Document revision history.	41

List of figures

Figure 1.	STM32F4DISCOVERY	1
Figure 2.	Hardware block diagram	8
Figure 3.	Top layout	9
Figure 4.	Bottom layout	10
Figure 5.	STM32F407VGT6 package	11
Figure 6.	STM32F407VGT6 block diagram	12
Figure 7.	Typical configuration	13
Figure 8.	STM32F4DISCOVERY connections image	14
Figure 9.	ST-Link connections image	15
Figure 10.	STM32F4DISCOVERY mechanical drawing	34
Figure 11.	STM32F4DISCOVERY	35
Figure 12.	ST-LINK/V2 (SWD only)	36
Figure 13.	MCU	37
Figure 14.	Audio	38
Figure 15.	USB_OTG_FS	39
Figure 16.	Peripherals	40

1 Conventions

Table 1 provides the definition of some conventions used in the present document.

Table 1. ON/OFF conventions

Convention	Definition
Jumper JP1 ON	Jumper fitted
Jumper JP1 OFF	Jumper not fitted
Solder bridge SBx ON	SBx connections closed by solder
Solder bridge SBx OFF	SBx connections left open

2 Quick start

The STM32F4DISCOVERY is a low-cost and easy-to-use development kit to quickly evaluate and start a development with an STM32F4 high-performance microcontroller.

Before installing and using the product, please accept the Evaluation Product License Agreement from www.st.com/stm32f4-discovery.

For more information on the STM32F4DISCOVERY and for demonstration software, visit www.st.com/stm32f4-discovery.

2.1 Getting started

Follow the sequence below to configure the STM32F4DISCOVERY board and launch the DISCOVER application:

1. Check jumper position on the board, JP1 on, CN3 on (DISCOVERY selected).
2. Connect the STM32F4DISCOVERY board to a PC with a USB cable 'type A to mini-B' through USB connector CN1 to power the board. Red LED LD2 (PWR) then lights up.
3. Four LEDs between B1 and B2 buttons are blinking.
4. Press user button B1 to enable the ST MEMS sensor, move the board and observe the four LEDs blinking according to the motion direction and speed. (If you connect a second USB cable 'type A to micro-B' between PC and CN5 connector then the board is recognized as standard mouse and its motion will also control the PC cursor).
5. To study or modify the DISCOVER project related to this demo, visit www.st.com/stm32f4-discovery and follow the tutorial.
6. Discover the STM32F4 features, download and execute programs proposed in the list of projects.
7. Develop your own application using available examples.

2.2 System requirements

- Windows PC (XP, Vista, 7)
- USB type A to Mini-B USB cable

2.3 Development toolchain supporting the STM32F4DISCOVERY

- Altium, TASKING™ VX-Toolset
- Atollic TrueSTUDIO®
- IAR Embedded Workbench® for ARM (EWARM)
- Keil™, MDK-ARM

2.4 Order code

To order the STM32F4 high-performance discovery board, use the order code STM32F4DISCOVERY.

3 Features

The STM32F4DISCOVERY offers the following features:

- STM32F407VGT6 microcontroller featuring 1 MB of Flash memory, 192 KB of RAM in an LQFP100 package
- On-board ST-LINK/V2 with selection mode switch to use the kit as a standalone ST-LINK/V2 (with SWD connector for programming and debugging)
- Board power supply: through USB bus or from an external 5V supply voltage
- External application power supply: 3V and 5V
- LIS302DL or LIS3DSH, ST MEMS motion sensor, 3-axis digital output accelerometer
- MP45DT02, ST MEMS audio sensor, omnidirectional digital microphone
- CS43L22, audio DAC with integrated class D speaker driver
- Eight LEDs:
 - LD1 (red/green) for USB communication
 - LD2 (red) for 3.3V power on
 - Four user LEDs, LD3 (orange), LD4 (green), LD5 (red) and LD6 (blue)
 - 2 USB OTG LEDs LD7 (green) VBus and LD8 (red) over-current
- Two pushbuttons (user and reset)
- USB OTG with micro-AB connector
- Extension header for LQFP100 I/Os for quick connection to prototyping board and easy probing

4 Hardware and layout

The STM32F4DISCOVERY is designed around the STM32F407VGT6 microcontroller in a 100-pin LQFP package.

Figure 2 illustrates the connections between the STM32F407VGT6 and its peripherals (ST-LINK/V2, pushbutton, LED, Audio DAC, USB, ST MEMS accelerometer, ST MEMS microphone, and connectors).

Figure 3 and Figure 4 help you to locate these features on the STM32F4DISCOVERY.

Figure 2. Hardware block diagram

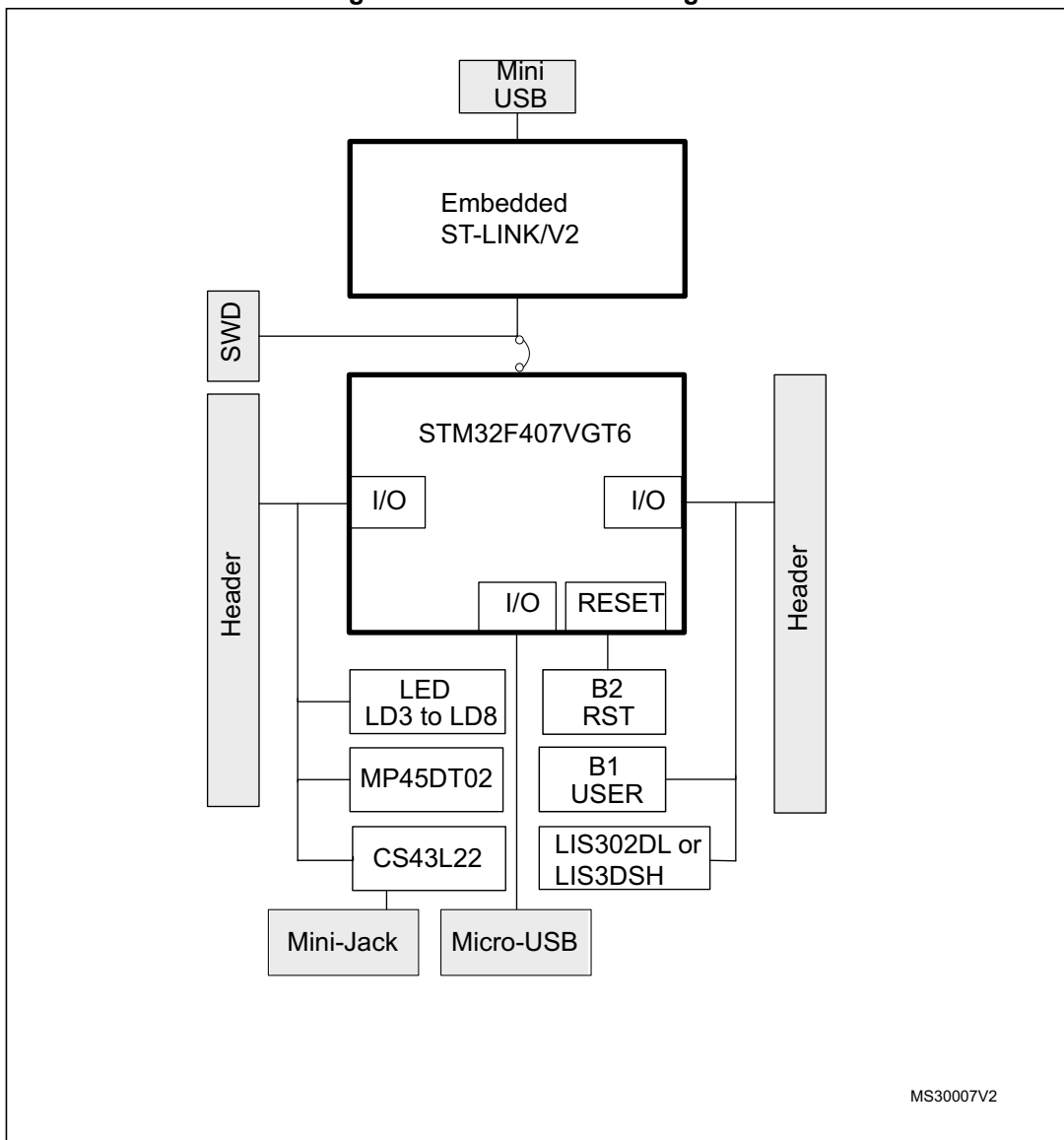
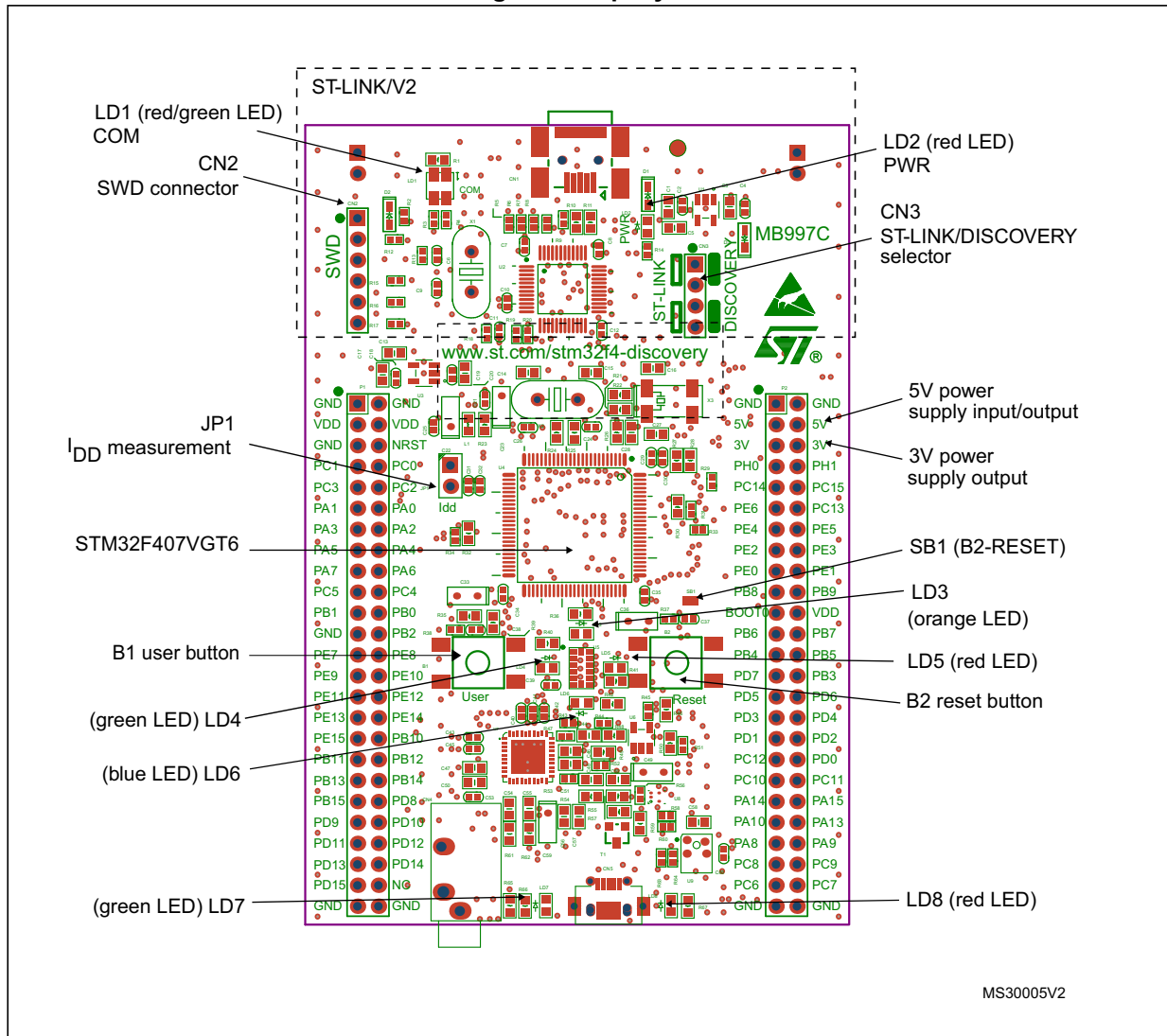
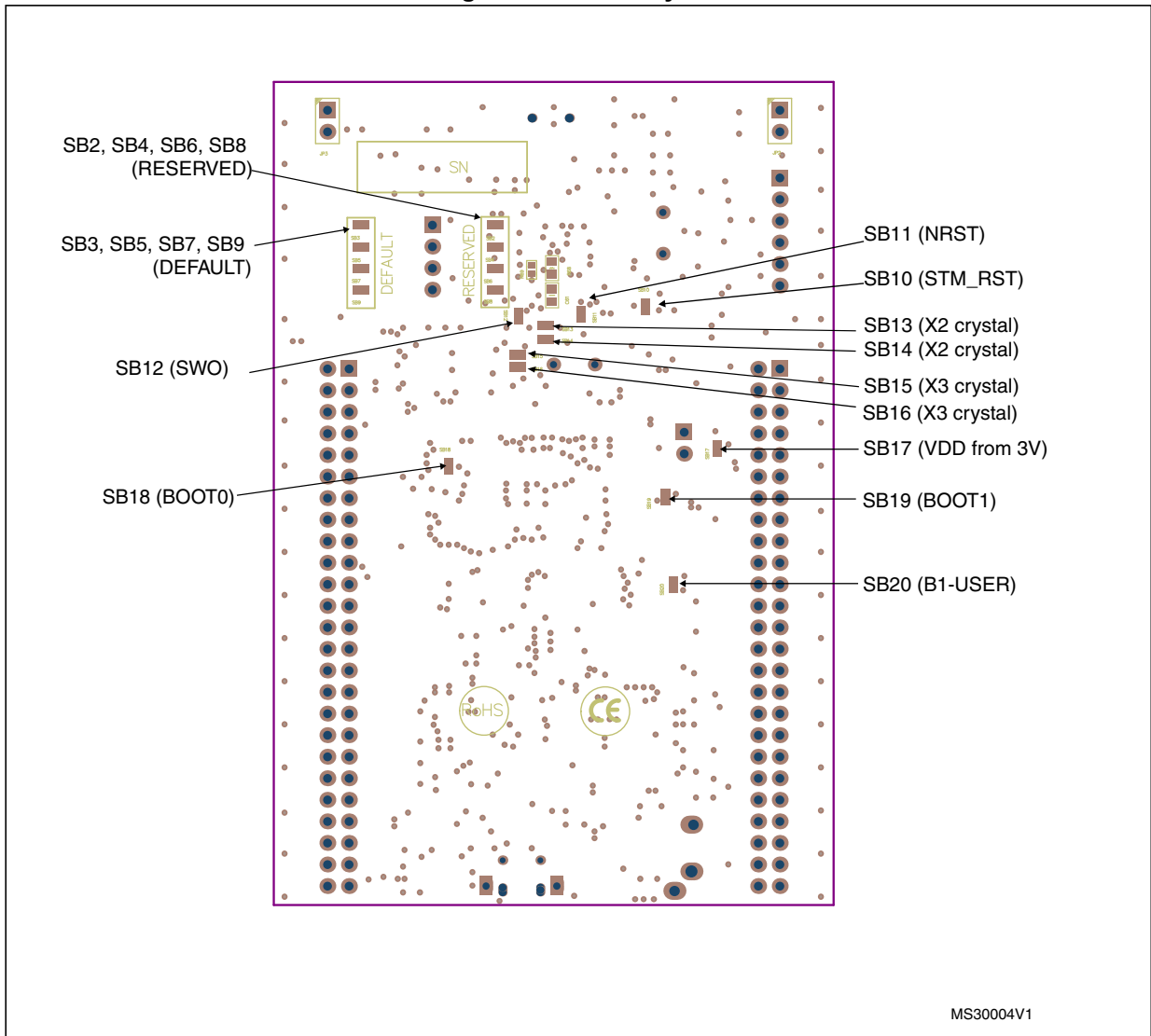

Figure 3. Top layout



Note: Pin 1 of CN2, CN3, JP1, P1 and P2 connectors are identified by a square.

Figure 4. Bottom layout



4.1 STM32F407VGT6 microcontroller

This ARM Cortex-M4 32-bit MCU with FPU has 210 DMIPS, up to 1 MB Flash/192+4 KB RAM, USB OTG HS/FS, Ethernet, 17 TIMs, 3 ADCs, 15 comm. interfaces and a camera.

Figure 5. STM32F407VGT6 package

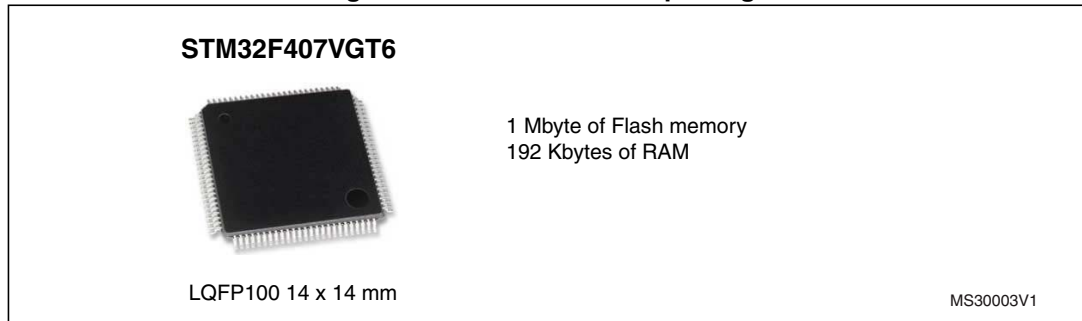

This device provides the following benefits.

- 168 MHz/210 DMIPS Cortex-M4 with single cycle DSP MAC and floating point unit providing:
 - Boosted execution of control algorithms
 - More features possible for your applications
 - Ease of use
 - Better code efficiency
 - Faster time to market
 - Elimination of scaling and saturation
 - Easier support for meta-language tools
- Designed for high performance and ultra fast data transfers; ART Accelerator, 32-bit, 7-layer AHB bus matrix with 7 masters and 8 slaves including 2 blocks of SRAM, Multi DMA controllers: 2 general purpose, 1 for USB HS, 1 for Ethernet, One SRAM block dedicated to the core, providing performance equivalent to 0-wait execution from Flash Concurrent execution and data transfers and simplified resource allocation
- Outstanding power efficiency; Ultra-low dynamic power, RTC <1 μ A typical in VBAT mode, 3.6 V down to 1.7 V VDD, Voltage regulator with power scaling capability, providing extra flexibility to reduce power consumption for applications requiring both high processing and low power performance when running at low voltage or on a rechargeable battery
- Maximum integration: Up to 1 Mbyte of on-chip Flash memory, 192 Kbytes of SRAM, reset circuit, internal RCs, PLLs, WLCSF package available, providing more features in space constrained applications
- Superior and innovative peripherals providing new possibilities to connect and communicate high speed data and more precision due to high resolution
- Extensive tools and software solutions providing a wide choice within the STM32 ecosystem to develop your applications.

Figure 6. STM32F407VGT6 block diagram

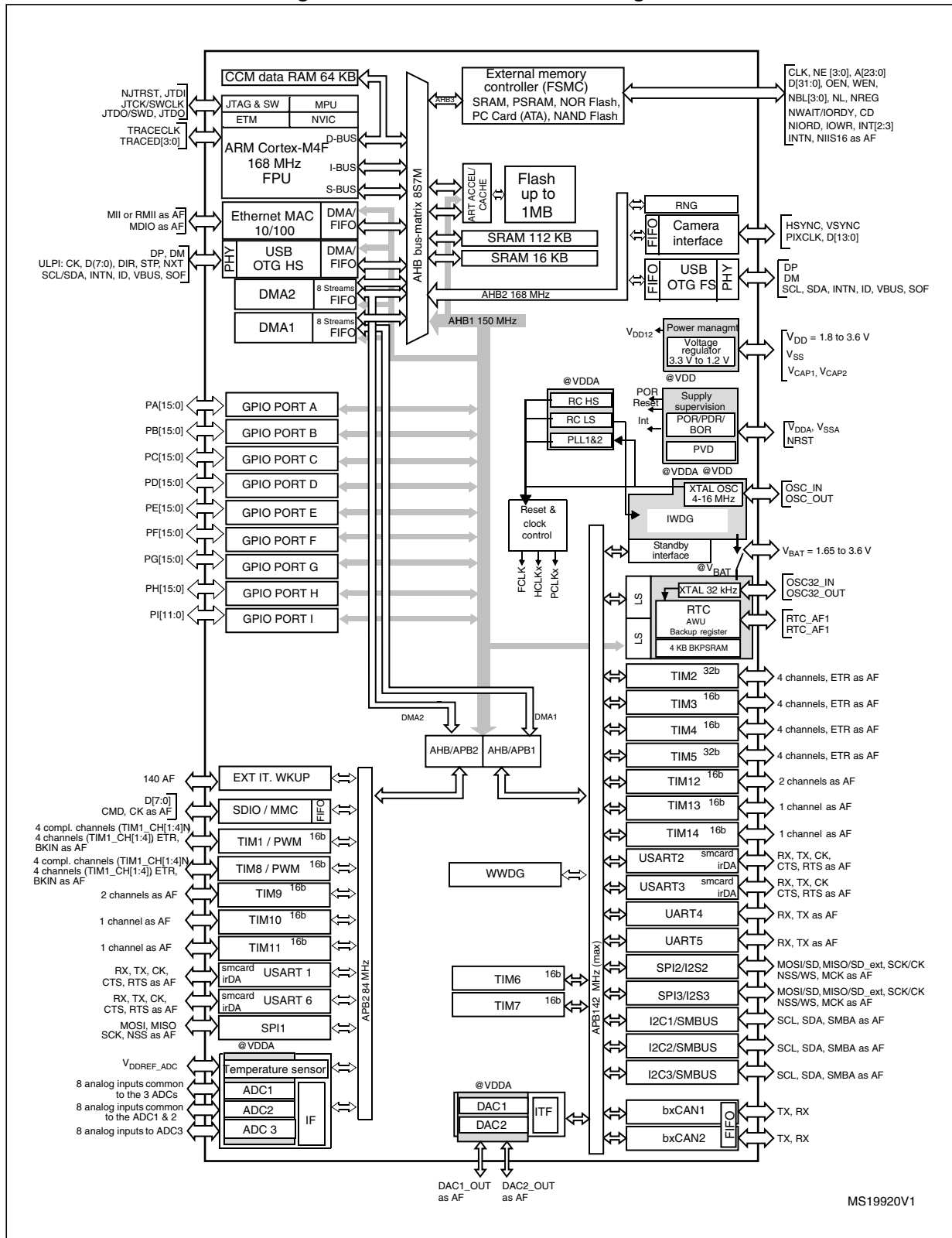

4.2 Embedded ST-LINK/V2

The ST-LINK/V2 programming and debugging tool is integrated on the STM32F4DISCOVERY. The embedded ST-LINK/V2 can be used in 2 different ways according to the jumper states (see [Table 2](#)):

- Program/debug the MCU on board,
- Program/debug an MCU in an external application board using a cable connected to SWD connector CN2.

The embedded ST-LINK/V2 supports only SWD for STM32 devices. For information about debugging and programming features refer to user manual UM1075 (*ST-LINK/V2 in-circuit debugger/programmer for STM8 and STM32*) which describes in detail all the ST-LINK/V2 features.

Figure 7. Typical configuration

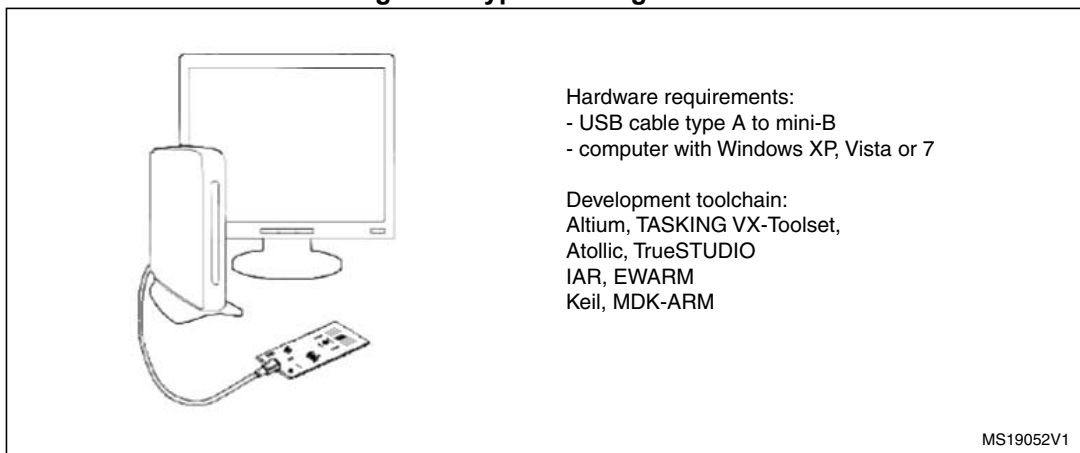

Table 2. Jumper states

Jumper state	Description
Both CN3 jumpers ON	ST-LINK/V2 functions enabled for on board programming (default)
Both CN3 jumpers OFF	ST-LINK/V2 functions enabled for application through external CN2 connector (SWD supported)

4.2.1 Using ST-LINK/V2 to program/debug the STM32F4 on board

To program the STM32F4 on board, simply plug in the two jumpers on CN3, as shown in *Figure 8* in red, but do not use the CN2 connector as that could disturb communication with the STM32F407VGT6 of the STM32F4DISCOVERY.

Figure 8. STM32F4DISCOVERY connections image

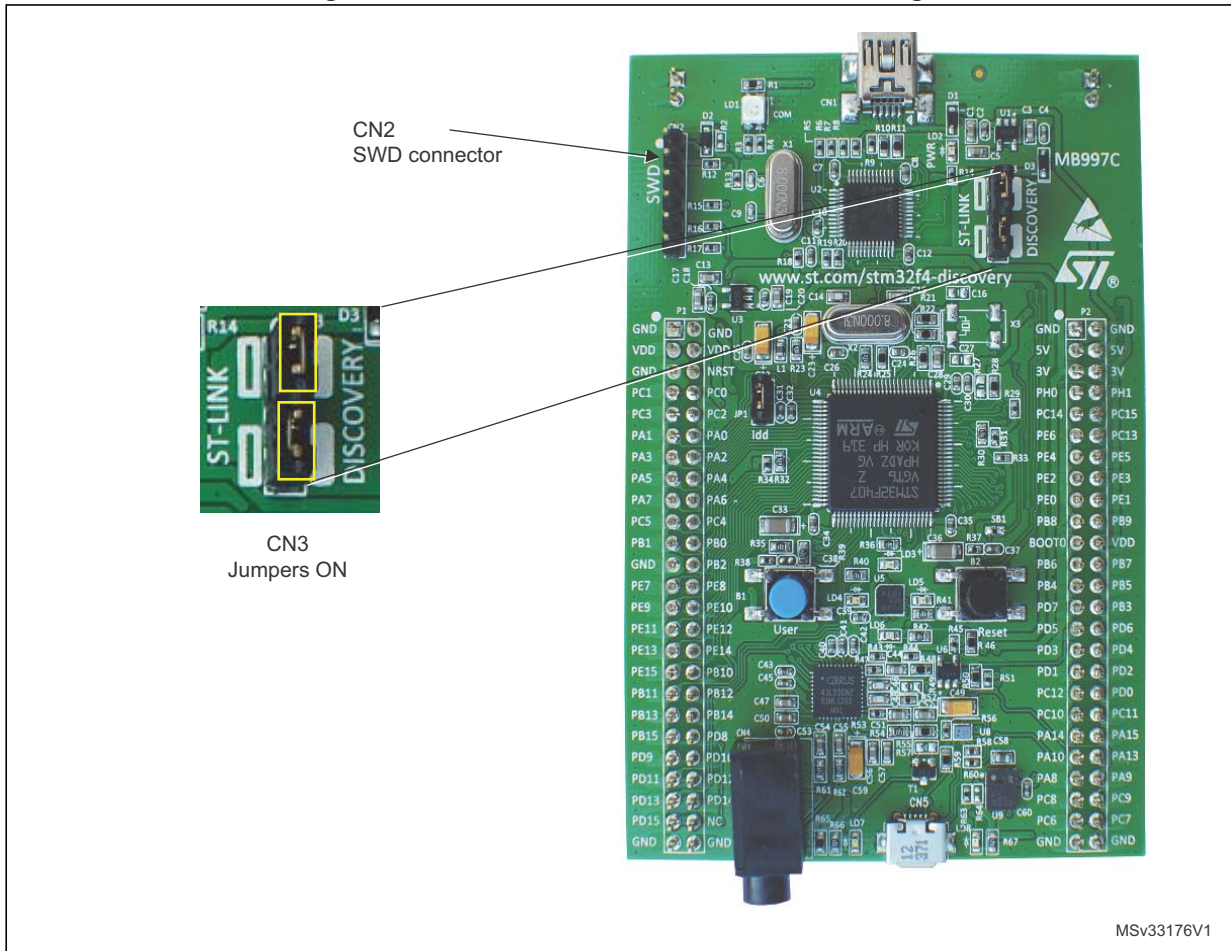

4.2.2 Using ST-LINK/V2 to program/debug an external STM32 application

It is very easy to use the ST-LINK/V2 to program the STM32 on an external application. Simply remove the 2 jumpers from CN3 as shown in *Figure 9*, and connect your application to the CN2 debug connector according to *Table 3*.

Note: SB11 must be OFF if you use CN2 pin 5 in your external application.

Table 3. Debug connector CN2 (SWD)

Pin	CN2	Designation
1	VDD_TARGET	VDD from application
2	SWCLK	SWD clock
3	GND	Ground
4	SWDIO	SWD data input/output
5	NRST	RESET of target MCU
6	SWO	Reserved

Figure 9. ST-Link connections image

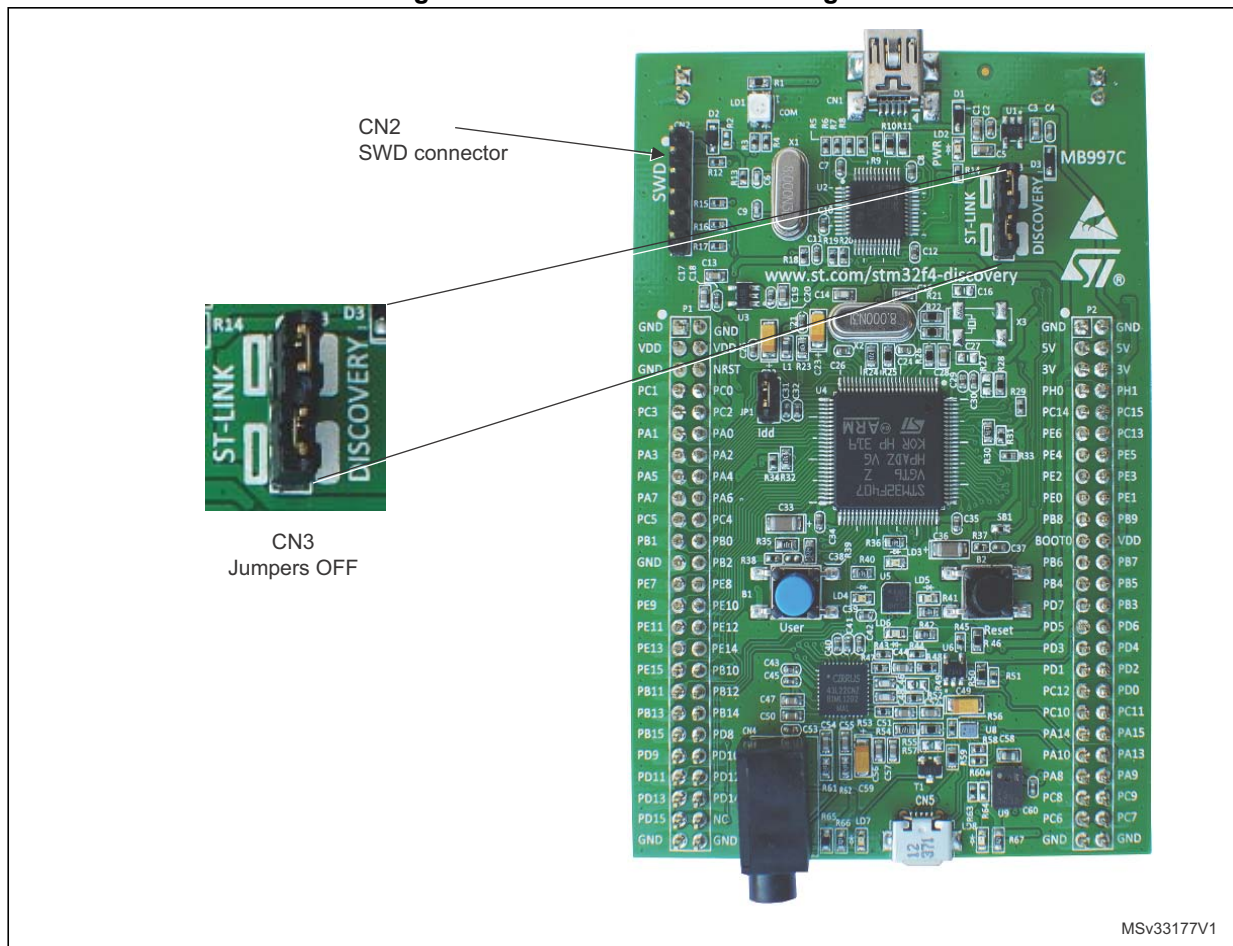

4.3 Power supply and power selection

The power supply is provided either by the host PC through the USB cable, or by an external 5V power supply.

The D1 and D2 diodes protect the 5V and 3V pins from external power supplies:

- 5V and 3V can be used as output power supplies when another application board is connected to pins P1 and P2.
In this case, the 5V and 3V pins deliver a 5V or 3V power supply and power consumption must be lower than 100 mA.
- 5V can also be used as input power supplies e.g. when the USB connector is not connected to the PC.
In this case, the STM32F4DISCOVERY board must be powered by a power supply unit or by auxiliary equipment complying with standard EN-60950-1: 2006+A11/2009, and must be Safety Extra Low Voltage (SELV) with limited power capability.

4.4 LEDs

- LD1 COM: LD1 default status is red. LD1 turns to green to indicate that communications are in progress between the PC and the ST-LINK/V2.
- LD2 PWR: red LED indicates that the board is powered.
- User LD3: orange LED is a user LED connected to the I/O PD13 of the STM32F407VGT6.
- User LD4: green LED is a user LED connected to the I/O PD12 of the STM32F407VGT6.
- User LD5: red LED is a user LED connected to the I/O PD14 of the STM32F407VGT6.
- User LD6: blue LED is a user LED connected to the I/O PD15 of the STM32F407VGT6.
- USB LD7: green LED indicates when VBUS is present on CN5 and is connected to PA9 of the STM32F407VGT6.
- USB LD8: red LED indicates an overcurrent from VBUS of CN5 and is connected to the I/O PD5 of the STM32F407VGT6.

4.5 Pushbuttons

- B1 USER: User and Wake-Up button connected to the I/O PA0 of the STM32F407VGT6.
- B2 RESET: Pushbutton connected to NRST is used to RESET the STM32F407VGT6.

4.6 On board audio capability

The STM32F4 uses an audio DAC (CS43L22) to output sounds through the audio mini jack connector.

The STM32F4 controls the audio DAC through the I2C interface and processes digital signals through I2S connection or analog input signal.

- The sound can come independently from different inputs:
 - ST MEMS microphone (MP45DT02): digital using PDM protocol or analog when using the low pass filter.
 - USB connector: from external mass storage such as a USB key, USB HDD, and so on.
 - Internal memory of the STM32F4.
- The sound can be output in different ways through audio DAC:
 - Using I2S protocol
 - Using the STM32F4 DAC to analog input AIN1x of the CS43L22
 - Using the microphone output directly via a low pass filter to analog input AIN4x of the CS43L22

4.7 USB OTG supported

The STM32F4 is used to drive only USB OTG full speed on this board. The USB micro-AB connector (CN5) allows the user to connect a host or device component, such as a USB key, mouse, and so on.

Two LEDs are dedicated to this module:

- LD7 (green LED) indicates when VBUS is active
- LD8 (red LED) indicates an overcurrent from connected device

4.8 Motion sensor (ST MEMS LIS302DL or LIS3DSH)

Two different versions of motion sensor (U5 in schematic) are available on the board depending the PCB version. The LIS302DL is present on board MB997B (PCB revision B) and the LIS3DSH is present on board MB997C (PCB rev C).

The LIS302DL or LIS3DSH are both an ultra compact low-power three-axis linear accelerometer.

It includes a sensing element and an IC interface able to provide the measured acceleration to the external world through I2C/SPI serial interface.

The LIS302DL has dynamically user selectable full scales of $\pm 2g/\pm 8g$ and it is capable of measuring acceleration with an output rate of 100Hz to 400Hz.

The LIS3DSH has $\pm 2g/\pm 4g/\pm 6g/\pm 8g/\pm 16g$ dynamically selectable full-scale and it is capable of measuring acceleration with an output data rate of 3.125 Hz to 1.6 kHz.

The STM32F4 controls this motion sensor through the SPI interface.

4.9 JP1 (I_{dd})

Jumper JP1, labeled I_{dd}, allows the consumption of STM32F407VGT6 to be measured by removing the jumper and connecting an ammeter.

- Jumper on: STM32F407VGT6 is powered (default).
- Jumper off: an ammeter must be connected to measure the STM32F407VGT6 current, (if there is no ammeter, the STM32F407VGT6 is not powered).

4.10 OSC clock

4.10.1 OSC clock supply

If PH0 and PH1 are only used as GPIOs instead of as a clock, then SB13 and SB14 are closed and R24, R25 and R68 are removed.

- **MCO from ST-LINK.** From MCO of the STM32F103. This frequency cannot be changed, it is fixed at 8 MHz and connected to PH0-OSC_IN of the STM32F407VGT6. Configuration needed:
 - SB13, SB14 OPEN
 - R25^(a) removed
 - R68^(a) soldered
- **Oscillator onboard.** From X2 crystal. For typical frequencies and its capacitors and resistors, please refer to the STM32F407VGT6 Datasheet. Configuration needed:
 - SB13, SB14 OPEN
 - R25^(a) soldered
 - R68^(a) removed
- **Oscillator from external PH0.** From external oscillator through pin 7 of the P2 connector. Configuration needed:
 - SB13 closed
 - SB14 closed
 - R25 and R68 removed

4.10.2 OSC 32 KHz clock supply

If PC14 and PC15 are only used as GPIOs instead of as a clock, then SB15 and SB16 are closed, and R21 and R22 are removed.

- **Oscillator onboard.** From X1 Crystal (not provided). Configuration needed:
 - SB15, SB16 OPEN
 - C16, C27, R21 and R22 soldered.
- **Oscillator from external PC14.** From external oscillator through the pin 9 of P2 connector. Configuration needed:
 - SB16 closed
 - SB15 closed
 - R21 and R22 removed

a. As the frequency supplied by X2 is the same as MCO (8 MHz) R25 and R68 are soldered.

4.11 Solder bridges

Table 4. Solder bridges

Bridge	State ⁽¹⁾	Description
SB13,14 (X2 crystal) ⁽²⁾	OFF	X2, C14, C15, R24 and R25 provide a clock. PH0, PH1 are disconnected from P2.
	ON	PH0, PH1 are connected to P2 (R24, R25 and R68 must not be fitted).
SB3,5,7,9 (Default)	ON	Reserved, do not modify.
SB2,4,6,8 (Reserved)	OFF	Reserved, do not modify.
SB15,16 (X3 crystal)	OFF	X3, C16, C27, R21 and R22 deliver a 32 KHz clock. PC14, PC15 are not connected to P2.
	ON	PC14, PC15 are only connected to P2. Remove only R21, R22
SB1 (B2-RESET)	ON	B2 pushbutton is connected to the NRST pin of the STM32F407VGT6 MCU.
	OFF	B2 pushbutton is not connected the NRST pin of the STM32F407VGT6 MCU.
SB20 (B1-USER)	ON	B1 pushbutton is connected to PA0.
	OFF	B1 pushbutton is not connected to PA0.
SB17 (VDD powered from 3V)	OFF	VDD is not powered from 3V, depends on JP1 jumper.
	ON	VDD is permanently powered from 3V, JP1 jumper has no effect.
SB11 (NRST)	ON	NRST signal of the CN2 connector is connected to the NRST pin of the STM32F407VGT6 MCU.
	OFF	NRST signal of the CN2 connector is not connected to the NRST pin of the STM32F407VGT6 MCU.
SB12 (SWO)	ON	SWO signal of the CN2 connector is connected to PB3.
	OFF	SWO signal is not connected.
SB10 (STM_RST)	OFF	No incidence on STM32F103C8T6 (ST-LINK/V2) NRST signal.
	ON	STM32F103C8T6 (ST-LINK/V2) NRST signal is connected to GND.
SB18 (BOOT0)	ON	BOOT0 signal of the STM32F407VGT6 MCU is held low through a 510 ohm pull-down resistor.
	OFF	BOOT0 signal of the STM32F407VGT6 MCU is held high through a 10 Kohm pull-up resistor.
SB19 (BOOT1)	OFF	The BOOT1 signal of the STM32F407VGT6 MCU is held high through a 10 Kohm pull-up resistor.
	ON	The BOOT1 signal of the STM32F407VGT6 MCU is held low through a 510 ohm pull-down resistor.

1. Default SBx state is shown in bold.

2. SB13 and SB14 are OFF to allow the user to choose between MCO and X2 crystal for clock source.

4.12 Extension connectors

The male headers P1 and P2 can connect the STM32F4DISCOVERY to a standard prototyping/wrapping board. STM32F407VGT6 GPI/Os are available on these connectors. P1 and P2 can also be probed by an oscilloscope, logical analyzer or voltmeter.

Table 5. MCU pin description versus board function

MCU pin		Board function														
Main function	Alternate functions	LQFP100	CS43L22	MP45DT02	LIS302DL or LIS3DSH	Pushbutton	LED	SWD	USB	OSC	Free I/O	Power supply	CN5	CN2	P1	P2
BOOT0	VPP	94	-	-	-	-	-	-	-	-	-	-	-	-	-	21
NRST	-	14	-	-	-	RESET	-	NRST	-	-	-	-	-	5	6	-
PA0-WKUP	USART2_CTS/ USART4_TX/ ETH_MII_CRX/ TIM2_CH1_ETR/ TIM5_CH1/ TIM8_ETR/ ADC123_IN0/ WKUP	23	-	-	-	USER	-	-	-	-	-	-	-	-	12	-
PA1	USART2_RTS/ USART4_RX/ ETH_RMII_REF_CLK/ ETH_MII_RX_CLK/ TIM5_CH2/ TIMM2_CH2/ ADC123_IN1	24	-	-	-	-	-	-	-	-	-	-	-	-	11	-
PA2	USART2_TX/ TIM5_CH3/ TIM9_CH1/ TIM2_CH3/ ETH_MDIO/ ADC123_IN2	25	-	-	-	-	-	-	-	-	-	-	-	-	14	-

Table 5. MCU pin description versus board function (continued)

MCU pin		Board function														
Main function	Alternate functions	LQFP100	CS43L22	MP45DT02	LIS302DL or LIS3DSH	Pushbutton	LED	SWD	USB	OSC	Free I/O	Power supply	CN5	CN2	P1	P2
PA3	USART2_RX/ TIM5_CH4/ TIM9_CH2/ TIM2_CH4/ OTG_HS_ULPI_D0/ ETH_MII_COL/ ADC123_IN3	26	-	-	-	-	-	-	-	-	-	-	-	-	13	-
PA4	SPI1_NSS/ SPI3_NSS/ USART2_CK/ DCMI_HSYNC/ OTG_HS_SOF/ I2S3_WS/ ADC12_IN4/ DAC1_OUT	29	LRCK/AIN1x	-	-	-	-	-	-	-	-	-	-	-	16	-
PA5	SPI1_SCK/ OTG_HS_ULPI_CK/ TIM2_CH1_ETR/ TIM8_CHIN/ ADC12_IN5/ DAC2_OUT	30	-	-	SCL/SPC	-	-	-	-	-	-	-	-	-	15	-
PA6	SPI1_MISO/ TIM8_BKIN/ TIM13_CH1/ DCMI_PIXCLK/ TIM3_CH1/ TIM1_BKIN/ ADC12_IN6	31	-	-	SDO	-	-	-	-	-	-	-	-	-	18	-
PA7	SPI1_MOSI/ TIM8_CH1N/ TIM14_CH1/TIM3_CH2/ ETH_MII_RX_DV/ TIM1_CH1N/ RMII_CRS_DV/ ADC12_IN7	32	-	-	SDA/SDI/SDO	-	-	-	-	-	-	-	-	-	17	-

Table 5. MCU pin description versus board function (continued)

MCU pin		Board function															
Main function	Alternate functions	LQFP100	CS43L22	MP45DT02	LIS302DL or LIS3DSH	Pushbutton	LED	SWD	USB	OSC	Free I/O	Power supply	CN5	CN2	P1	P2	
PA8	MCO1/ USART1_CK/ TIM1_CH1/ I2C3_SCL/ OTG_FS_SOF	67	-	-	-	-	-	-	-	-	-	-	-	-	-	-	43
PA9	USART1_TX/ TIM1_CH2/ I2C3_SMBA/ DCMI_D0/ OTG_FS_VBUS	68	-	-	-	-	GREEN	-	VBUS	-	-	-	1	-	-	-	44
PA10	USART1_RX/ TIM1_CH3/ OTG_FS_ID/ DCMI_D1	69	-	-	-	-	-	-	ID	-	-	-	4	-	-	-	41
PA11	USART1_CTS/ CAN1_RX/ TIM1_CH4/ OTG_FS_DM	70	-	-	-	-	-	-	DM	-	-	-	2	-	-	-	-
PA12	USART1_RTS/ CAN1_TX/ TIM1_ETR/ OTG_FS_DP	71	-	-	-	-	-	-	DP	-	-	-	3	-	-	-	-
PA13	JTMS-SWDIO	72	-	-	-	-	-	SWDIO	-	-	-	-	-	4	-	-	42
PA14	JTCK-SWCLK	76	-	-	-	-	-	SWCLK	-	-	-	-	-	2	-	-	39
PA15	JTDI/ SPI3_NSS/ I2S3_WS/ TIM2_CH1_ETR/ SPI1_NSS	77	-	-	-	-	-	-	-	-	-	-	-	-	-	-	40

Table 5. MCU pin description versus board function (continued)

MCU pin		Board function														
Main function	Alternate functions	LQFP100	CS43L22	MP45DT02	LIS302DL or LIS3DSH	Pushbutton	LED	SWD	USB	OSC	Free I/O	Power supply	CN5	CN2	P1	P2
PB0	TIM3_CH3/ TIM8_CH2N/ OTG_HS_ULPI_D1/ ETH_MII_RXD2/ TIM1_CH2N/ ADC12_IN8	35	-	-	-	-	-	-	-	-	-	-	-	-	22	-
PB1	TIM3_CH4/ TIM8_CH3N/ OTG_HS_ULPI_D2/ ETH_MII_RXD3/ OTG_HS_INTN/ TIM1_CH3N/ ADC12_IN9	36	-	-	-	-	-	-	-	-	-	-	-	-	21	-
PB2	-	37	-	-	-	-	-	-	-	-	-	-	-	-	24	-
PB3	JTDO/ TRACESWO/ SPI3_SCK/ I2S3_CK/ TIM2_CH2/ SPI1_SCK	89	-	-	-	-	-	SWO	-	-	-	-	-	6	-	28
PB4	NJTRST/ SPI3_MISO/ TIM3_CH1/ SPI1_MISO/ I2S3ext_SD	90	-	-	-	-	-	-	-	-	-	-	-	-	-	25
PB5	I2C1_SMBA/ CAN2_RX/ OTG_HS_ULPI_D7/ ETH_PPS_OUT/ TIM3_CH2/ SPI1_MOSI/ SPI3_MOSI/ DCMI_D10/ I2S3_SD	91	-	-	-	-	-	-	-	-	-	-	-	-	-	26



Table 5. MCU pin description versus board function (continued)

MCU pin		Board function														
Main function	Alternate functions	LQFP100	CS43L22	MP45DT02	LIS302DL or LIS3DSH	Pushbutton	LED	SWD	USB	OSC	Free I/O	Power supply	CN5	CN2	P1	P2
PB6	I2C1_SCL/ TIM4_CH1/ CAN2_TX/ OTG_FS_INTN/ DCMI_D5/ USART1_TX	92	SCL	-	-	-	-	-	-	-	-	-	-	-	-	23
PB7	I2C1_SDA/ FSMC_NL/ DCMI_VSYNC/ USART1_RX/ TIM4_CH2	93	-	-	-	-	-	-	-	-	-	-	-	-	-	24
PB8	TIM4_CH3/ SDIO_D4/ TIM10_CH1/ DCMI_D6/ OTG_FS_SCL/ ETH_MII_TXD3/ I2C1_SCL/ CAN1_RX	95	-	-	-	-	-	-	-	-	-	-	-	-	-	19
PB9	SPI2_NSS/ I2S2_WS/ TIM4_CH4/ TIM11_CH1/ OTG_FS_SDA/ SDIO_D5/ DCMI_D7/ I2C1_SDA/ CAN1_TX	96	SDA	-	-	-	-	-	-	-	-	-	-	-	-	20
PB10	SPI2_SCK/ I2S2_CK/ I2C2_SCL/ USART3_TX/ OTG_HS_ULPI_D3/ ETH_MII_RX_ER/ OTG_HS_SCL/ TIM2_CH3	47	-	CLK	-	-	-	-	-	-	-	-	-	-	34	-

Table 5. MCU pin description versus board function (continued)

MCU pin		Board function														
Main function	Alternate functions	LQFP100	CS43L22	MP45DT02	LIS302DL or LIS3DSH	Pushbutton	LED	SWD	USB	OSC	Free I/O	Power supply	CN5	CN2	P1	P2
PB11	I2C2_SDA/ USART3_RX/ OTG_HS_ULPI_D4/ ETH_RMII_TX_EN/ ETH_MII_TX_EN/ OTG_HS_SDA/ TIM2_CH4	48	-	-	-	-	-	-	-	-	-	-	-	-	35	-
PB12	SPI2_NSS/ I2S2_WS/ I2C2_SMBA/ USART3_CK/ TIM1_BKIN/ CAN2_RX/ OTG_HS_ULPI_D5/ ETH_RMII_TXD0/ ETH_MII_TXD0/ OTG_HS_ID	51	-	-	-	-	-	-	-	-	-	-	-	-	36	-
PB13	SPI2_SCK/ I2S2_CK/ USART3_CTS/ TIM1_CH1N/ CAN2_TX/ OTG_HS_ULPI_D6/ ETH_RMII_TXD1/ ETH_MII_TXD1/ OTG_HS_VBUS	52	-	-	-	-	-	-	-	-	-	-	-	-	37	-
PB14	SPI2_MISO/ TIM1_CH2N/ TIM12_CH1/ OTG_HS_DMUSART3 _RTS/ TIM8_CH2N/ I2S2ext_SD	53	-	-	-	-	-	-	-	-	-	-	-	-	38	-

Table 5. MCU pin description versus board function (continued)

MCU pin		Board function														
Main function	Alternate functions	LQFP100	CS43L22	MP45DT02	LIS302DL or LIS3DSH	Pushbutton	LED	SWD	USB	OSC	Free I/O	Power supply	CN5	CN2	P1	P2
PB15	SPI2_MOSI/ I2S2_SD/ TIM1_CH3N/ TIM8_CH3N/ TIM12_CH2/ OTG_HS_DP	54	-	-	-	-	-	-	-	-	-	-	-	-	39	-
PC0	OTG_HS_ULPI_STP/ ADC123_IN10	15	-	-	-	-	-	-	PowerOn	-	-	-	-	-	8	-
PC1	ETH_MDC/ ADC123_IN11	16	-	-	-	-	-	-	-	-	-	-	-	-	7	-
PC2	SPI2_MISO/ OTG_HS_ULPI_DIR/ TH_MII_TXD2/ I2S2ext_SD/ ADC123_IN12	17	-	-	-	-	-	-	-	-	-	-	-	-	10	-
PC3	SPI2_MOSI/ I2S2_SD/ OTG_HS_ULPI_NXT/ ETH_MII_TX_CLK/ ADC123_IN13	18	-	DOU/AIN4x	-	-	-	-	-	-	-	-	-	-	9	-
PC4	ETH_RMII_RX_D0/ ETH_MII_RX_D0/ ADC12_IN14	33	-	-	-	-	-	-	-	-	-	-	-	-	20	-
PC5	ETH_RMII_RX_D1/ ETH_MII_RX_D1/ ADC12_IN15	34	-	-	-	-	-	-	-	-	-	-	-	-	19	-
PC6	I2S2_MCK/ TIM8_CH1/ SDIO_D6/ USART6_TX/ DCMI_D0/ TIM3_CH1	63	-	-	-	-	-	-	-	-	-	-	-	-	-	47

Table 5. MCU pin description versus board function (continued)

MCU pin		Board function														
Main function	Alternate functions	LQFP100	CS43L22	MP45DT02	LIS302DL or LIS3DSH	Pushbutton	LED	SWD	USB	OSC	Free I/O	Power supply	CN5	CN2	P1	P2
PC7	I2S3_MCK/ TIM8_CH2/ SDIO_D7/ USART6_RX/ DCMI_D1/ TIM3_CH2	64	MCLK	-	-	-	-	-	-	-	-	-	-	-	-	48
PC8	TIM8_CH3/ SDIO_D0/ TIM3_CH3/ USART6_CK/ DCMI_D2	65	-	-	-	-	-	-	-	-	-	-	-	-	-	45
PC9	I2S_CKIN/ MCO2/ TIM8_CH4/ SDIO_D1/ I2C3_SDA/ DCMI_D3/ TIM3_CH4	66	-	-	-	-	-	-	-	-	-	-	-	-	-	46
PC10	SPI3_SCK/ I2S3_CK/ UART4_TX/ SDIO_D2/ DCMI_D8/ USART3_TX	78	SCLK	-	-	-	-	-	-	-	-	-	-	-	-	37
PC11	UART4_RX/ SPI3_MISO/ SDIO_D3/ DCMI_D4/ USART3_RX/ I2S3ext_SD	79	-	-	-	-	-	-	-	-	-	-	-	-	-	38
PC12	UART5_TX/ SDIO_CK/ DCMI_D9/ SPI3_MOSI/ I2S3_SD/ USART3_CK	80	SDIN	-	-	-	-	-	-	-	-	-	-	-	-	35

Table 5. MCU pin description versus board function (continued)

MCU pin		Board function															
Main function	Alternate functions	LQFP100	CS43L22	MP45DT02	LIS302DL or LIS3DSH	Pushbutton	LED	SWD	USB	OSC	Free I/O	Power supply	CN5	CN2	P1	P2	
PC13	RTC_AF1	7	-	-	-	-	-	-	-	-	-	-	-	-	-	-	12
PC14	OSC32_IN	8	-	-	-	-	-	-	-	OSC32_IN	-	-	-	-	-	-	9
PC15	OSC32_OUT	9	-	-	-	-	-	-	-	OSC32_OUT	-	-	-	-	-	-	10
PD0	FSMC_D2/ CAN1_RX	81	-	-	-	-	-	-	-	-	-	-	-	-	-	-	36
PD1	FSMC_D3/ CAN1_TX	82	-	-	-	-	-	-	-	-	-	-	-	-	-	-	33
PD2	TIM3_ETR/ USART5_RXSDIO_CMD / DCMI_D11	83	-	-	-	-	-	-	-	-	-	-	-	-	-	-	34
PD3	FSMC_CLK/ USART2_CTS	84	-	-	-	-	-	-	-	-	-	-	-	-	-	-	31
PD4	FSMC_NOE/ USART2_RTS	85	RESET	-	-	-	-	-	-	-	-	-	-	-	-	-	32
PD5	FSMC_NWE/ USART2_TX	86	-	-	-	-	RED	-	OverCurrent	-	-	-	-	-	-	-	29
PD6	FSMC_NWAIT/ USART2_RX	87	-	-	-	-	-	-	-	-	-	-	-	-	-	-	30
PD7	USART2_CK/ FSMC_NE1/ FSMC_NCE2	88	-	-	-	-	-	-	-	-	-	-	-	-	-	-	27

Table 5. MCU pin description versus board function (continued)

MCU pin		Board function														
Main function	Alternate functions	LQFP100	CS43L22	MP45DT02	LIS302DL or LIS3DSH	Pushbutton	LED	SWD	USB	OSC	Free I/O	Power supply	CN5	CN2	P1	P2
PD8	FSMC_D13/ USART3_TX	55	-	-	-	-	-	-	-	-	-	-	-	-	40	-
PD9	FSMC_D14/ USART3_RX	56	-	-	-	-	-	-	-	-	-	-	-	-	41	-
PD10	FSMC_D15/ USART3_CK	57	-	-	-	-	-	-	-	-	-	-	-	-	42	-
PD11	FSMC_A16/ USART3_CTS	58	-	-	-	-	-	-	-	-	-	-	-	-	43	-
PD12	FSMC_A17/ TIM4_CH1/ USART3_RTS	59	-	-	-	-	GREEN	-	-	-	-	-	-	-	44	-
PD13	FSMC_A18/ TIM4_CH2	60	-	-	-	-	ORANGE	-	-	-	-	-	-	-	45	-
PD14	FSMC_D0/ TIM4_CH3	61	-	-	-	-	RED	-	-	-	-	-	-	-	46	-
PD15	FSMC_D1/ TIM4_CH4	62	-	-	-	-	BLUE	-	-	-	-	-	-	-	47	-
PE0	TIM4_ETR/ FSMC_NBL0/ DCMI_D2	97	-	-	INT1	-	-	-	-	-	-	-	-	-	-	17
PE1	FSMC_NBL1/ DCMI_D3	98	-	-	INT2	-	-	-	-	-	-	-	-	-	-	18
PE2	TRACECLK/ FSMC_A23/ ETH_MII_TXD3	1	-	-	-	-	-	-	-	-	-	-	-	-	-	15
PE3	TRACED0/ FSMC_A19	2	-	-	CS_12C/SPI	-	-	-	-	-	-	-	-	-	-	16

Table 5. MCU pin description versus board function (continued)

MCU pin		Board function														
Main function	Alternate functions	LQFP100	CS43L22	MP45DT02	LIS302DL or LIS3DSH	Pushbutton	LED	SWD	USB	OSC	Free I/O	Power supply	CN5	CN2	P1	P2
PE4	TRACED1/ FSMC_A20/ DCMI_D4	3	-	-	-	-	-	-	-	-	-	-	-	-	-	13
PE5	TRACED2/ FSMC_A21/ TIM9_CH1/ DCMI_D6	4	-	-	-	-	-	-	-	-	-	-	-	-	-	14
PE6	TRACED3/ FSMC_A22/ TIM9_CH2/ DCMI_D7	5	-	-	-	-	-	-	-	-	-	-	-	-	-	11
PE7	FSMC_D4/ TIM1_ETR	38	-	-	-	-	-	-	-	-	-	-	-	-	25	-
PE8	FSMC_D5/ TIM1_CH1N	39	-	-	-	-	-	-	-	-	-	-	-	-	26	-
PE9	FSMC_D6/ TIM1_CH1	40	-	-	-	-	-	-	-	-	-	-	-	-	27	-
PE10	FSMC_D7/ TIM1_CH2N	41	-	-	-	-	-	-	-	-	-	-	-	-	28	-
PE11	FSMC_D8/ TIM1_CH2	42	-	-	-	-	-	-	-	-	-	-	-	-	29	-
PE12	FSMC_D9/ TIM1_CH3N	43	-	-	-	-	-	-	-	-	-	-	-	-	30	-
PE13	FSMC_D10/ TIM1_CH3	44	-	-	-	-	-	-	-	-	-	-	-	-	31	-
PE14	FSMC_D11/ TIM1_CH4	45	-	-	-	-	-	-	-	-	-	-	-	-	32	-
PE15	FSMC_D12/ TIM1_BKIN	46	-	-	-	-	-	-	-	-	-	-	-	-	33	-
PH0	OSC_IN	12	-	-	-	-	-	-	-	OSC_IN	-	-	-	-	-	7

Table 5. MCU pin description versus board function (continued)

MCU pin		Board function														
Main function	Alternate functions	LQFP100	CS43L22	MP45DT02	LIS302DL or LIS3DSH	Pushbutton	LED	SWD	USB	OSC	Free I/O	Power supply	CN5	CN2	P1	P2
PH1	OSC_OUT	13	-	-	-	-	-	-	-	OSC_OUT	-	-	-	-	-	8
-	-	-	-	-	-	-	-	-	-	-	-	5V	-	-	-	3
-	-	-	-	-	-	-	-	-	-	-	-	5V	-	-	-	4
-	-	-	-	-	-	-	-	-	-	-	-	3V	-	-	-	5
-	-	-	-	-	-	-	-	-	-	-	-	3V	-	-	-	6
-	-	-	-	-	-	-	-	-	-	-	-	VDD	-	-	3	-
-	-	-	-	-	-	-	-	-	-	-	-	VDD	-	-	4	-
-	-	-	-	-	-	-	-	-	-	-	-	VDD	-	-	-	22
-	-	-	-	-	-	-	-	GND	GND	-	-	GND	5	3	1	-
-	-	-	-	-	-	-	-	-	-	-	-	GND	-	-	2	-
-	-	-	-	-	-	-	-	-	-	-	-	GND	-	-	5	-
-	-	-	-	-	-	-	-	-	-	-	-	GND	-	-	23	-
-	-	-	-	-	-	-	-	-	-	-	-	GND	-	-	49	-
-	-	-	-	-	-	-	-	-	-	-	-	GND	-	-	50	-
-	-	-	-	-	-	-	-	-	-	-	-	GND	-	-	-	1
-	-	-	-	-	-	-	-	-	-	-	-	GND	-	-	-	2

Table 5. MCU pin description versus board function (continued)

MCU pin		Board function															
Main function	Alternate functions	LQFP100	CS43L22	MP45DT02	LIS302DL or LIS3DSH	Pushbutton	LED	SWD	USB	OSC	Free I/O	Power supply	CN5	CN2	P1	P2	
		-	-	-	-	-	-	-	-	-	-	GND	-	-	-	-	49
-	-	-	-	-	-	-	-	-	-	-	-	GND	-	-	-	-	50

5 Mechanical drawing

Figure 10. STM32F4DISCOVERY mechanical drawing

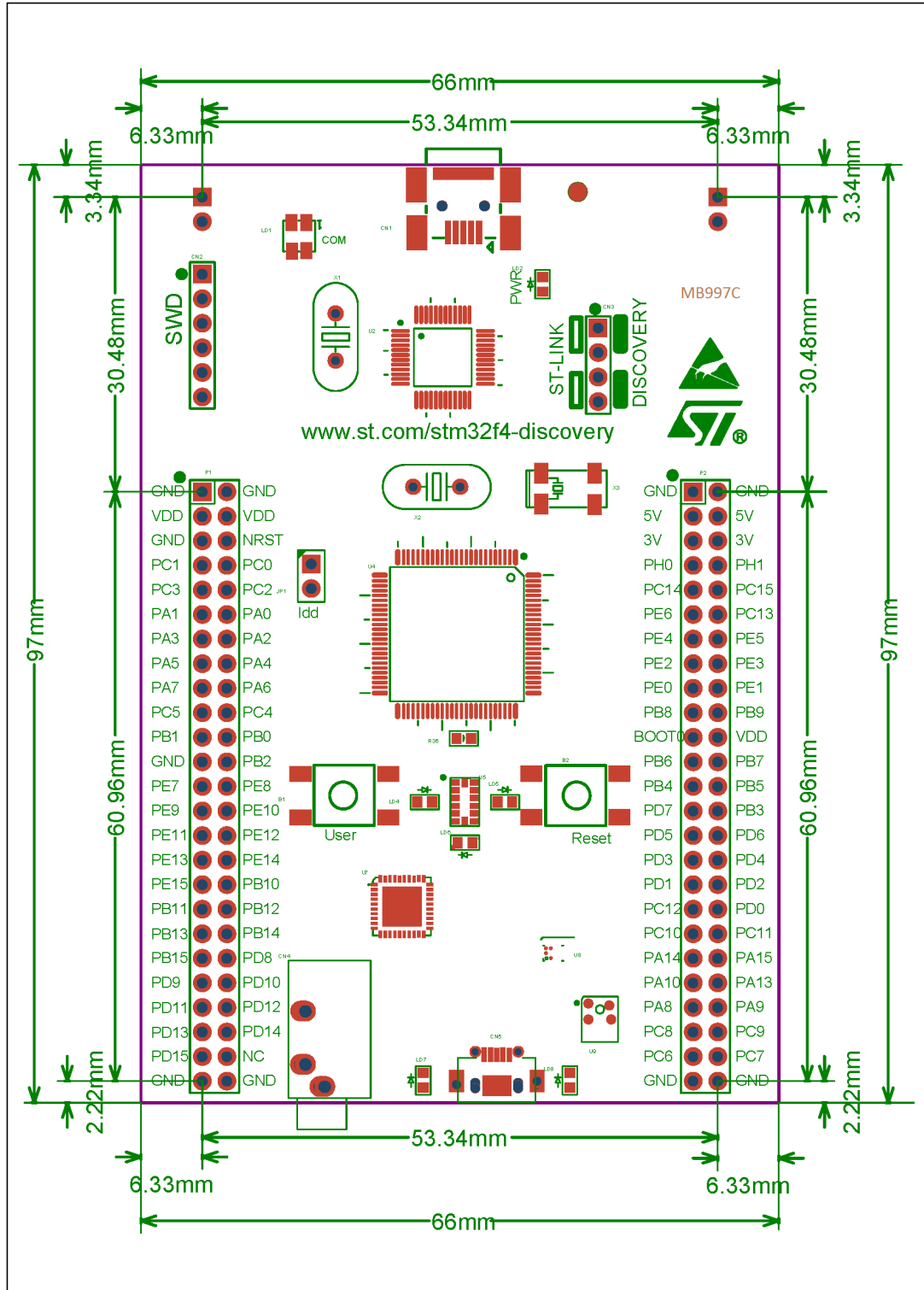

6 Electrical schematics

Figure 11. STM32F4DISCOVERY

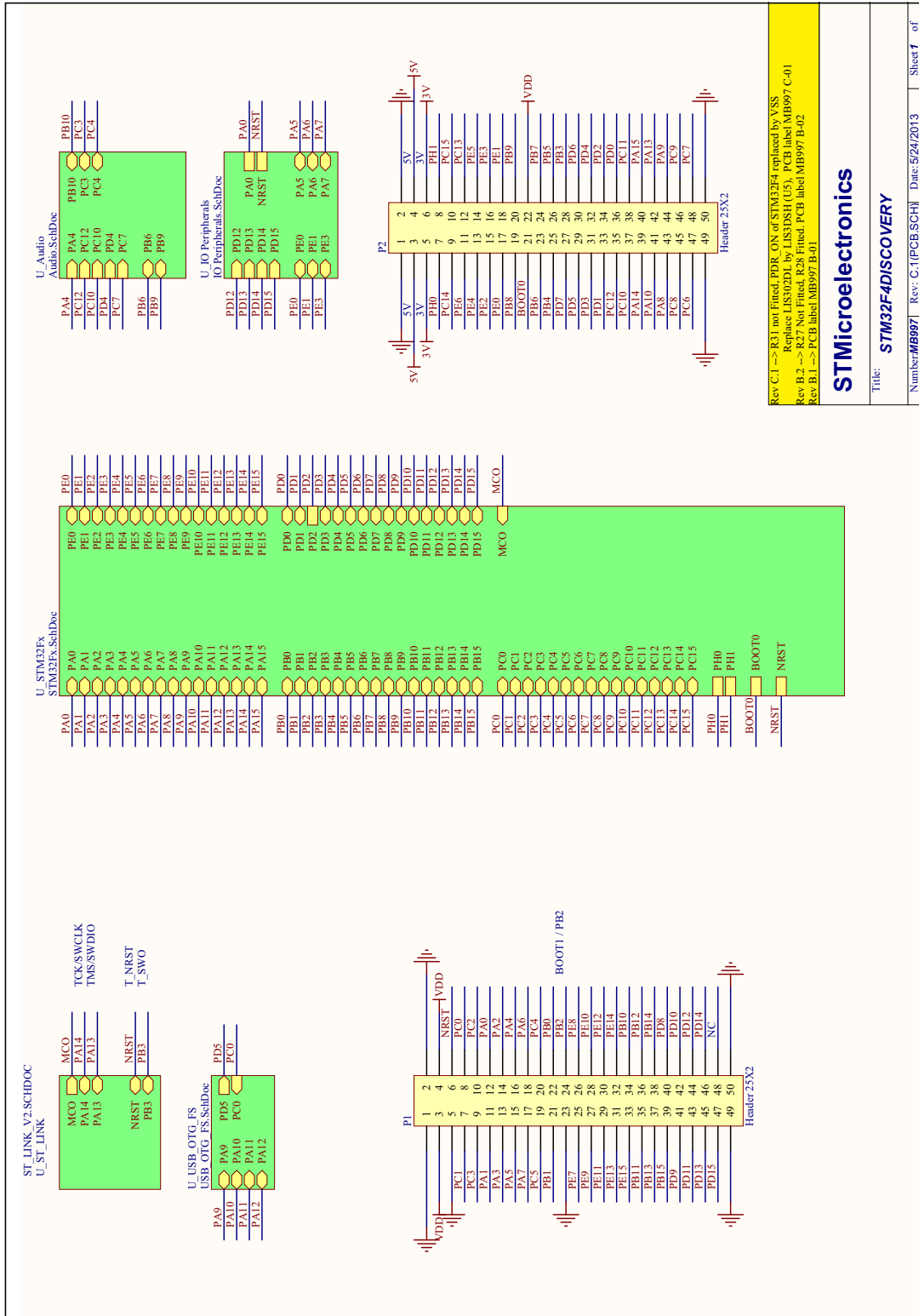

Rev C.1 -> R31 not fitted, PDR_ON of STM32F4 replaced by VSS
Replace LIS302DL by LIS3DSH (US), PCB label MB997 C-01
Rev B.2 -> R27 Not Fitted, R28 Fitted, PCB label MB997 B-02
Rev B.1 -> PCB label MB997 B-01

STMicroelectronics

Title: **STM32F4DISCOVERY**

Number: **MB997** Rev: C.1 [PCB_SCH] Date: 5/24/2013 Sheet 7 of



Figure 14. Audio

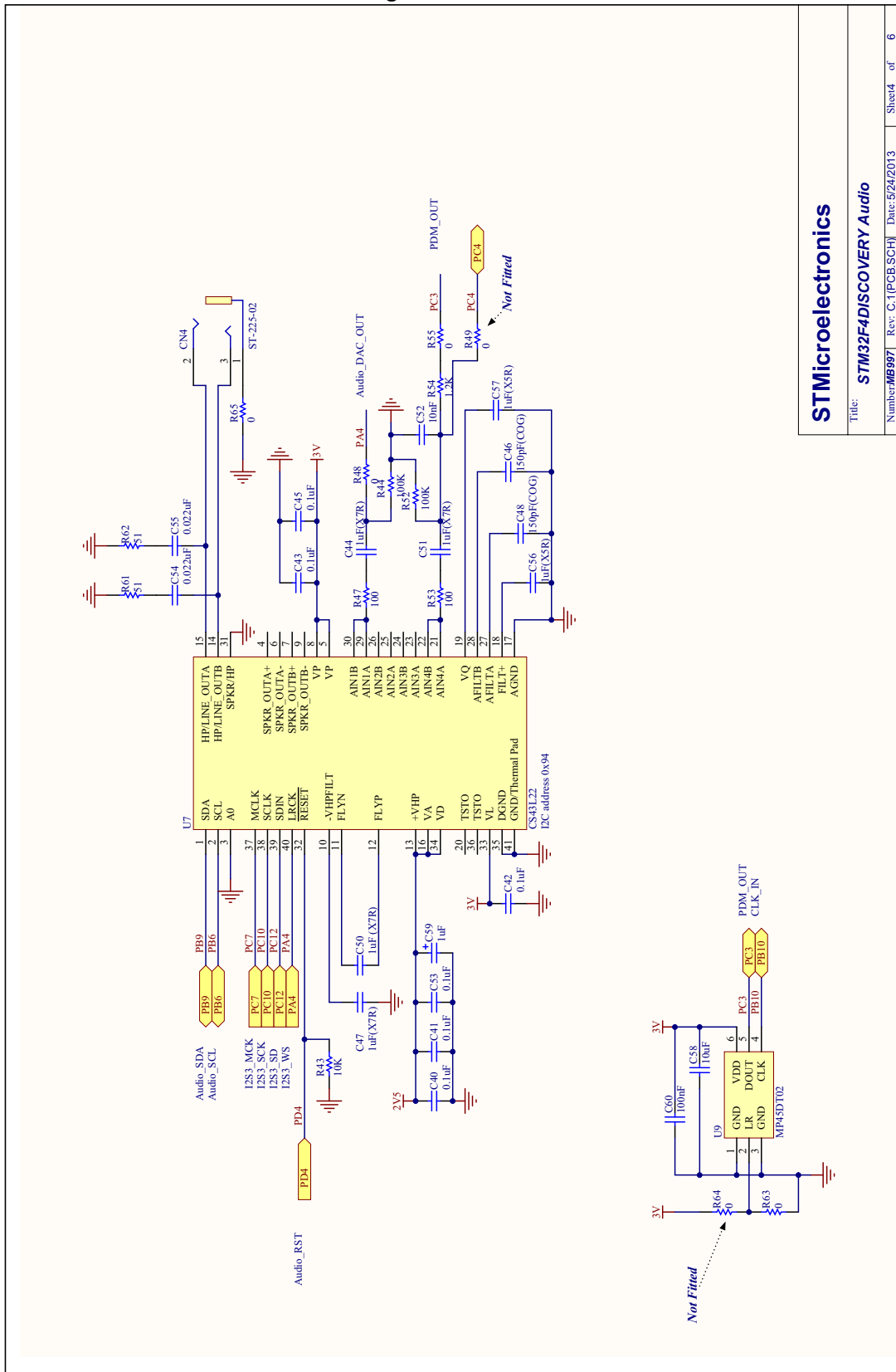

STMicroelectronics

Title: STM32F4DISCOVERY Audio

Number: MB997 Rev: C:1[PCB.SCH] Date: 5/24/2013 Sheet of 6



Figure 16. Peripherals

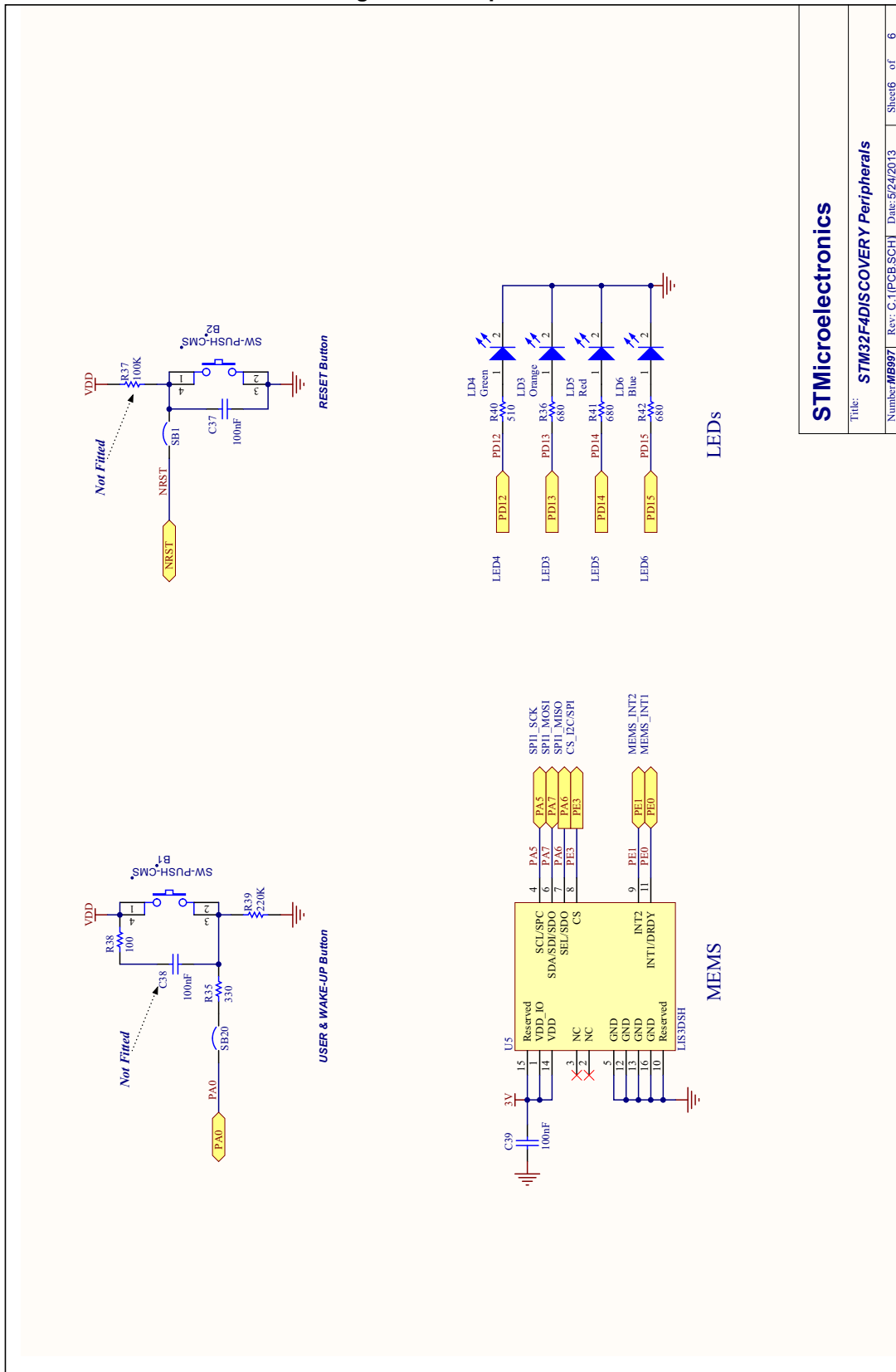

STMicroelectronics
 Title: **STM32F4DISCOVERY Peripherals**
 Number: **MB997** Rev: C-1[PCB.SCH] Date: 5/24/2013 Sheet 6 of 6



7 Revision history

Table 6. Document revision history

Date	Revision	Changes
27-Sept-2011	1	Initial release.
30-Jan-2012	2	Added <i>Section 4.1: STM32F407VGT6 microcontroller</i> corrected <i>Figure 3</i> MCU name, modified <i>Figure 2</i> and <i>Chapter 6: Electrical schematics</i> . Modified <i>Table 5</i> PE2 and PE3 entries.
28-Nov-2013	3	Updated for board rev. C. Modified title. Modified <i>Section 4.8: Motion sensor (ST MEMS LIS302DL or LIS3DSH)</i> Updated <i>Chapter 6: Electrical schematics</i>
29-Jan-2014	4	Modified <i>Chapter 3: Features, Figure 2, Chapter 4.8: Motion sensor (ST MEMS LIS302DL or LIS3DSH)</i> , <i>Table 5</i> adding ST MEMS LIS302DL reference.

Please Read Carefully:

Information in this document is provided solely in connection with ST products. STMicroelectronics NV and its subsidiaries ("ST") reserve the right to make changes, corrections, modifications or improvements, to this document, and the products and services described herein at any time, without notice.

All ST products are sold pursuant to ST's terms and conditions of sale.

Purchasers are solely responsible for the choice, selection and use of the ST products and services described herein, and ST assumes no liability whatsoever relating to the choice, selection or use of the ST products and services described herein.

No license, express or implied, by estoppel or otherwise, to any intellectual property rights is granted under this document. If any part of this document refers to any third party products or services it shall not be deemed a license grant by ST for the use of such third party products or services, or any intellectual property contained therein or considered as a warranty covering the use in any manner whatsoever of such third party products or services or any intellectual property contained therein.

UNLESS OTHERWISE SET FORTH IN ST'S TERMS AND CONDITIONS OF SALE ST DISCLAIMS ANY EXPRESS OR IMPLIED WARRANTY WITH RESPECT TO THE USE AND/OR SALE OF ST PRODUCTS INCLUDING WITHOUT LIMITATION IMPLIED WARRANTIES OF MERCHANTABILITY, FITNESS FOR A PARTICULAR PURPOSE (AND THEIR EQUIVALENTS UNDER THE LAWS OF ANY JURISDICTION), OR INFRINGEMENT OF ANY PATENT, COPYRIGHT OR OTHER INTELLECTUAL PROPERTY RIGHT.

ST PRODUCTS ARE NOT DESIGNED OR AUTHORIZED FOR USE IN: (A) SAFETY CRITICAL APPLICATIONS SUCH AS LIFE SUPPORTING, ACTIVE IMPLANTED DEVICES OR SYSTEMS WITH PRODUCT FUNCTIONAL SAFETY REQUIREMENTS; (B) AERONAUTIC APPLICATIONS; (C) AUTOMOTIVE APPLICATIONS OR ENVIRONMENTS, AND/OR (D) AEROSPACE APPLICATIONS OR ENVIRONMENTS. WHERE ST PRODUCTS ARE NOT DESIGNED FOR SUCH USE, THE PURCHASER SHALL USE PRODUCTS AT PURCHASER'S SOLE RISK, EVEN IF ST HAS BEEN INFORMED IN WRITING OF SUCH USAGE, UNLESS A PRODUCT IS EXPRESSLY DESIGNATED BY ST AS BEING INTENDED FOR "AUTOMOTIVE, AUTOMOTIVE SAFETY OR MEDICAL" INDUSTRY DOMAINS ACCORDING TO ST PRODUCT DESIGN SPECIFICATIONS. PRODUCTS FORMALLY ESCC, QML OR JAN QUALIFIED ARE DEEMED SUITABLE FOR USE IN AEROSPACE BY THE CORRESPONDING GOVERNMENTAL AGENCY.

Resale of ST products with provisions different from the statements and/or technical features set forth in this document shall immediately void any warranty granted by ST for the ST product or service described herein and shall not create or extend in any manner whatsoever, any liability of ST.

ST and the ST logo are trademarks or registered trademarks of ST in various countries.

Information in this document supersedes and replaces all information previously supplied.

The ST logo is a registered trademark of STMicroelectronics. All other names are the property of their respective owners.

© 2014 STMicroelectronics - All rights reserved

STMicroelectronics group of companies

Australia - Belgium - Brazil - Canada - China - Czech Republic - Finland - France - Germany - Hong Kong - India - Israel - Italy - Japan - Malaysia - Malta - Morocco - Philippines - Singapore - Spain - Sweden - Switzerland - United Kingdom - United States of America

www.st.com